

V24.04

Occupational Employment Dataset (*OED*) Glossary

Guide to understanding terms used in the Employee Registry

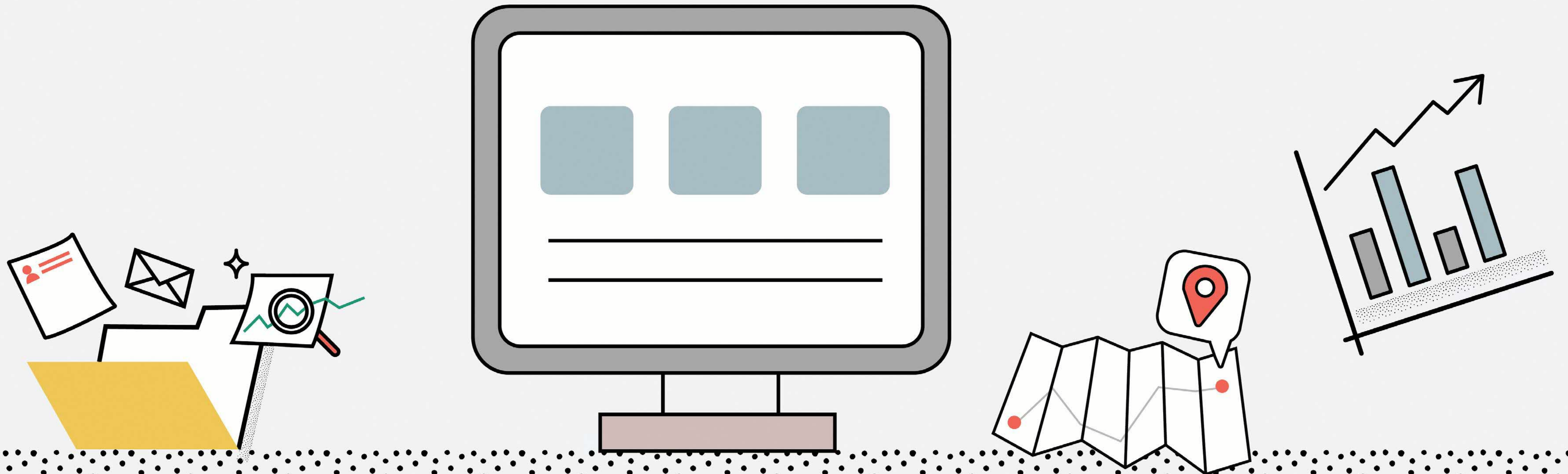

Getting Started

Personal Details

Identification No.

ID Type

Job Details

PWM Minimum Wages

PWM Job Description

Main Job Title

Columns for Financial Institutions

Occupation Group

Type of Employee

Full Time/Part Time

Hours Worked

Contractual Working Hours (Per Week)

Total Paid OT Hours

Total Number of Working Days in the Month

Actual Number of Days/Hours Worked in the Month

Wages & Benefits

Mode of Payment

Basic Wage

Gross Wage Received

Annual Leave Entitlements

Work Location Details

Premise Type

Employee Departure Details

Mode of Leaving

Getting Started

Hello and welcome to this guidebook!

In this guidebook, you'll find detailed explanations for terms used in the OED Employee Listing. For easy access, click on the content page and icons to jump to the relevant sections.

Hours Worked

Contractual Working Hours (Per Week)

Total Paid OT Hours

Total Number of Working Days in the Month

Actual Number of Days/Hours Worked in the Month



Group 3



A range of topics is covered in the guidebook such as Contractual Working Hours and Progressive Wage Model (PWM). PWM in Singapore is a wage ladder system that aims to provide workers with skills upgrading and career progression opportunities in specific industries.

New to PWM? Click [here](#) to find out more!

Getting Started

Personal Details

Identification No.

ID Type

Job Details

PWM Minimum Wages

PWM Job Description

Main Job Title

Columns for Financial Institutions

Occupation Group

Type of Employee

Full Time/Part Time

Hours Worked

Contractual Working Hours (Per Week)

Total Paid OT Hours

Total Number of Working Days in the Month

Actual Number of Days/Hours Worked in the Month

Wages & Benefits

Mode of Payment

Basic Wage

Gross Wage Received

Annual Leave Entitlements

Work Location Details

Premise Type

Employee Departure Details

Mode of Leaving

Identification Number



Singaporeans & PRs born:

Before 1 January 2000: NRIC will begin with "S".

1 January 2000 onwards: NRIC will begin with "T".

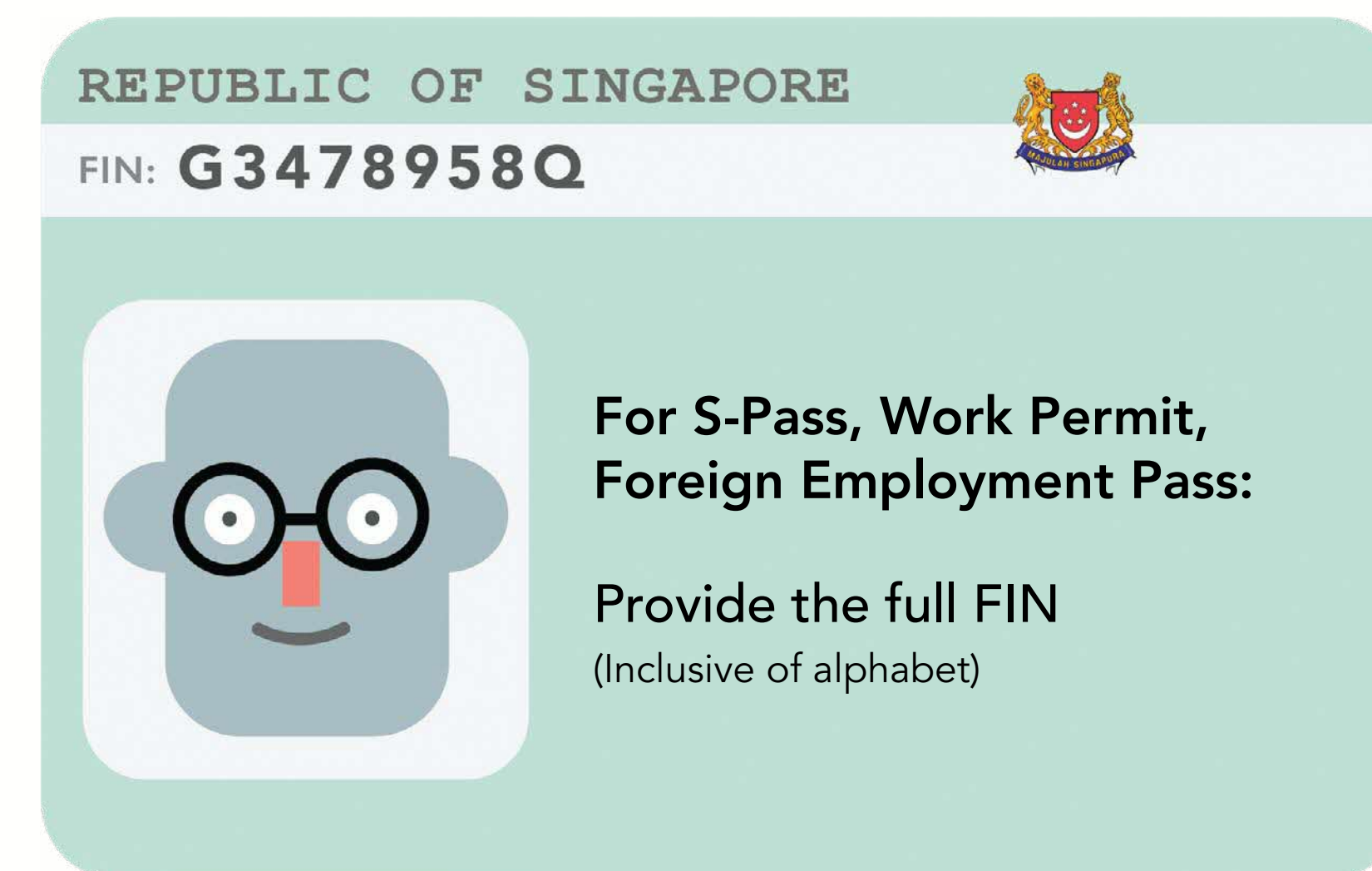

Foreigners with FINs issued:

Before 1 January 2000: FIN will begin with "F".

Between 1 January – 31 December 2021: FIN will begin with "G".

1 January 2022 onwards: FIN will begin with "M".

Getting Started**Personal Details**

Identification No.

ID Type

Job Details

PWM Minimum Wages

PWM Job Description

Main Job Title

Columns for Financial Institutions

Occupation Group

Type of Employee

Full Time/Part Time

Hours Worked

Contractual Working Hours (Per Week)

Total Paid OT Hours

Total Number of Working Days in the Month

Actual Number of Days/Hours Worked in the Month

Wages & Benefits

Mode of Payment

Basic Wage

Gross Wage Received

Annual Leave Entitlements

Work Location Details

Premise Type

Employee Departure Details

Mode of Leaving

ID Type

Singaporean Citizen / PR**Employment Pass**

- Employment Pass
- Personalised Employment Pass

S-Pass**Work Permit**

- Work Permit for Migrant Worker
- Work Permit for Domestic Worker
- Work Permit for Confinement Nanny
- Work Permit for Performing Artiste

Other Work Pass

- Training Work Permit
- Entre Pass
- Overseas Networks and Expertise Pass
- Training Employment Pass
- Work Holiday Pass
- Miscellaneous Work Pass
- Work Pass Exemption for Foreign Students
- Work Passes for Holders of Long-Term Visit Passes issues by ICA

Family Members

- Dependent's Pass
- LVTP
- Pre-approved Letter of Consent
- LOC for ICA-Issued LVTP
- LVTP+ holders
- LOC for dependent's pass holders who are business partners

Getting Started

Personal Details

Identification No.

ID Type

Job Details

PWM Minimum Wages

PWM Job Description

Main Job Title

Columns for Financial Institutions

Occupation Group

Type of Employee

Full Time/Part Time

Hours Worked

Contractual Working Hours (Per Week)

Total Paid OT Hours

Total Number of Working Days in the Month

Actual Number of Days/Hours Worked in the Month

Wages & Benefits

Mode of Payment

Basic Wage

Gross Wage Received

Annual Leave Entitlements

Work Location Details

Premise Type

Employee Departure Details

Mode of Leaving

PWM Minimum Wages

To ensure fair wages for all workers, Singapore Citizens and Permanent Residents (PRs) in Sectoral and Occupational PWM jobs must receive minimum wages corresponding to their job role.

To determine the appropriate minimum wage for the employee's job role:

Click on the icons below to find out more about the types of career pathway and minimum wages for each sector.



Cleaning Sector



Retail Sector



Landscape Sector



Waste Management



Security Sector



Administrators & Drivers

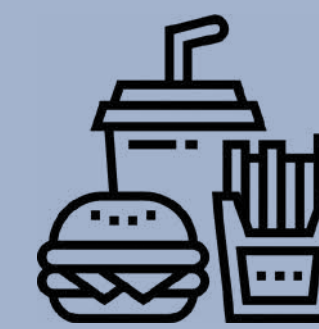

Food Services Sector

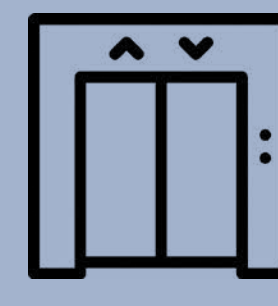

Lift & Escalator Sector

Getting Started

Personal Details

Identification No.

ID Type

Job Details

PWM Minimum Wages

PWM Job Description

Main Job Title

Columns for Financial Institutions

Occupation Group

Type of Employee

Full Time/Part Time

Hours Worked

Contractual Working Hours (Per Week)

Total Paid OT Hours

Total Number of Working Days in the Month

Actual Number of Days/Hours Worked in the Month

Wages & Benefits

Mode of Payment

Basic Wage

Gross Wage Received

Annual Leave Entitlements

Work Location Details

Premise Type

Employee Departure Details

Mode of Leaving

PWM Job Description

Click on the icons for a list of job descriptions to help identify the employee's job role.



Cleaning:
Conservancy



Cleaning:
F&B



Cleaning: Office
& Commercial

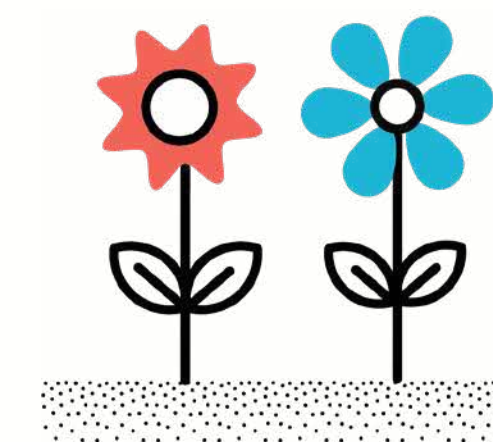

Landscape

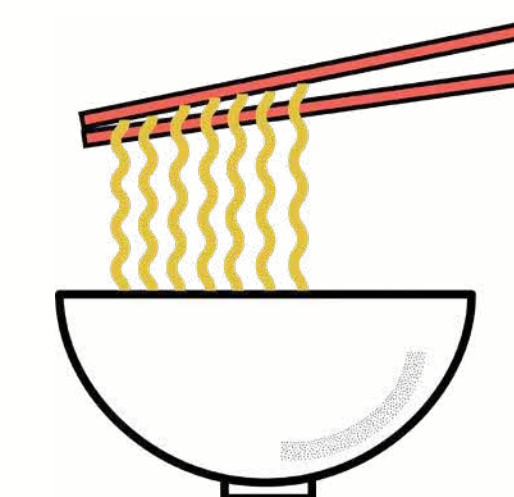

Food
Services

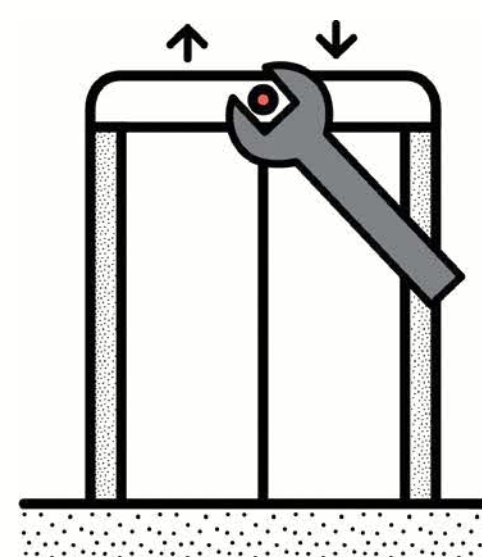

Lift
& Escalator

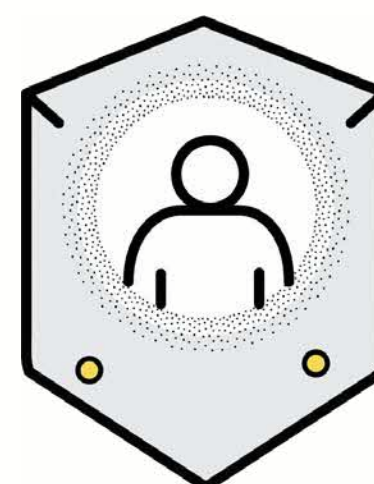

Security



Waste Managment:
Waste Collection/
Materials Recovery

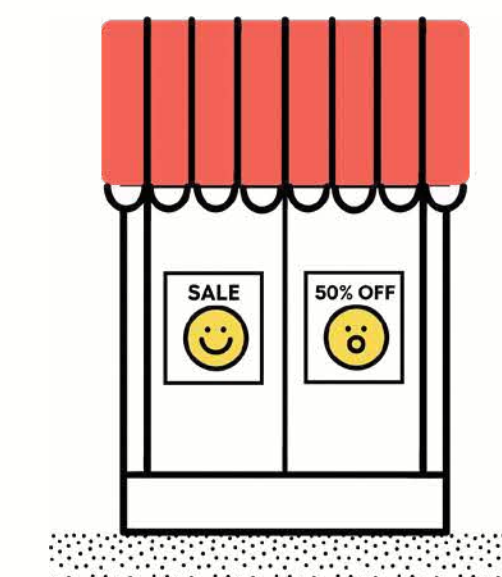

Retail

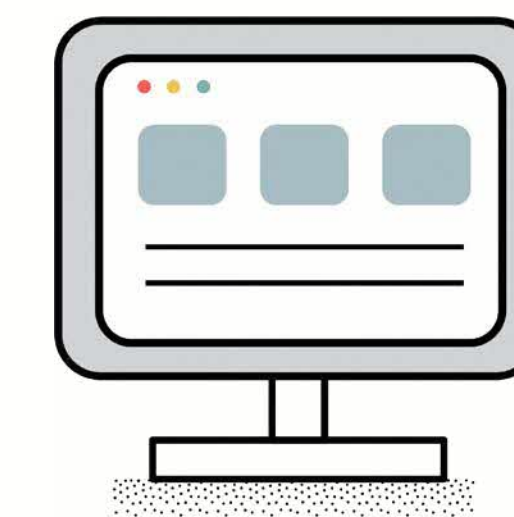

Administrators
& Drivers

Getting Started

Personal Details

Identification No.

ID Type

Job Details

PWM Minimum Wages

PWM Job Description

Main Job Title

Columns for Financial Institutions

Occupation Group

Type of Employee

Full Time/Part Time

Hours Worked

Contractual Working Hours (Per Week)

Total Paid OT Hours

Total Number of Working Days in the Month

Actual Number of Days/Hours Worked in the Month

Wages & Benefits

Mode of Payment

Basic Wage

Gross Wage Received

Annual Leave Entitlements

Work Location Details

Premise Type

Employee Departure Details

Mode of Leaving

[< Back to PWM Job Description](#)

Cleaning: Conservancy

General Cleaner – Performs basic cleaning duties such as wiping tables and windows; vacuuming carpets; pantry cleaning; clearing trash bins, cobweb; sweeping apron and surrounding drains, staircases, common corridor, outdoor, carpark/s; mopping lift and lift landing.

Restroom Cleaner – Performs cleaning duties in restrooms such as cleaning sanitation fixtures (E.g. cubicles, mirrors, sinks and urinals, refilling tissues, soaps, air fresheners and sanitisers), mopping floor, clearing trash and other general cleaning.

Refuse Collector – Collects and clears refuse (both dry and wet waste) at collection areas such as main refuse chute of HDB block or central bin chute. Clears and removes bulky waste; clean refuse chute; transport heavy loads and sweep car parks.

Mechanical Drivers – Operates motorized vehicles to sweep access road and pavements. The un-laden weight of equipments used (E.g. road sweeper) does not exceed 2,500 kg.

Cleaning Supervisor – Supervises a team of workers and monitor their performance. Responsible for planning operations, manpower and deployment. They also oversee work execution.

Multi-skilled Cleaner/ Machine Operator – Uses at least 1 motorized ride-on machinery; or at least 1 lifting equipment; or specialized cleaning agents; or at least 3 handheld machines besides vacuum cleaner, blower and general household cleaning equipment.

Operates motorized equipment to perform duties such as carpet shampooing; marble polishing; leaf blowing; refuse collection; sweeping access road, turf area, open and contained space (E.g. Areas within shopping centres and supermarkets), surrounding road-side and submerge drains, drop-inlet chamber; cleaning high areas of dust and cobwebs, glass panes, or any height cleaning that requires more than 2m access.



Getting Started

Personal Details

Identification No.

ID Type

Job Details

PWM Minimum Wages

PWM Job Description

Main Job Title

Columns for Financial Institutions

Occupation Group

Type of Employee

Full Time/Part Time

Hours Worked

Contractual Working Hours (Per Week)

Total Paid OT Hours

Total Number of Working Days in the Month

Actual Number of Days/Hours Worked in the Month

Wages & Benefits

Mode of Payment

Basic Wage

Gross Wage Received

Annual Leave Entitlements

Work Location Details

Premise Type

Employee Departure Details

Mode of Leaving

[< Back to PWM Job Description](#)

Cleaning: F&B Establishment

General Cleaner – Performs basic cleaning duties such as wiping tables and windows; vacuuming carpets; pantry cleaning; clearing trash bins, cobweb; sweeping apron and surrounding drains, staircases, common corridor, outdoor, carpark/s; mopping lift and lift landing.

Restroom Cleaner – Performs cleaning duties in restrooms such as cleaning sanitation fixtures (E.g. cubicles, mirrors, sinks and urinals, refilling tissues, soaps, air fresheners and sanitisers), mopping floor, clearing trash and other general cleaning.

Refuse Collector – Collects and clears refuse (both dry and wet waste) at collection areas such as main refuse chute of HDB block or central bin chute. Clears and removes bulky waste; clean refuse chute; transport heavy loads and sweep car parks.

Table-Top Cleaner – Performs duties at tray-return station, collects crockery and clean tables.

Cleaning Supervisor – Supervises a team of workers and monitor their performance. Responsible for planning operations, manpower and deployment. They also oversee work execution.

Dishwasher – Washes plates, trays and utensils. He/she may be required to operate dishwashing equipment. He/she transports plates, trays and utensils in and out of dishwashing bay by using push carts or conveyor belts.

Multi-skilled Cleaner/ Machine Operator – Uses at least 1 motorized ride-on machinery; or at least 1 lifting equipment; or specialized cleaning agents; or at least 3 handheld machines besides vacuum cleaner, blower and general household cleaning equipment.

Operates motorized equipment to perform duties such as carpet shampooing; marble polishing; leaf blowing; refuse collection; sweeping access road, turf area, open and contained space (E.g. Areas within shopping centres and supermarkets), surrounding road-side and submerge drains, drop-inlet chamber; cleaning high areas of dust and cobwebs, glass panes, or any height cleaning that requires more than 2m access.



Getting Started

Personal Details

Identification No.

ID Type

Job Details

PWM Minimum Wages

PWM Job Description

Main Job Title

Columns for Financial Institutions

Occupation Group

Type of Employee

Full Time/Part Time

Hours Worked

Contractual Working Hours (Per Week)

Total Paid OT Hours

Total Number of Working Days in the Month

Actual Number of Days/Hours Worked in the

Month

Wages & Benefits

Mode of Payment

Basic Wage

Gross Wage Received

Annual Leave Entitlements

Work Location Details

Premise Type

Employee Departure Details

Mode of Leaving

[< Back to PWM Job Description](#)

Cleaning: Office & Commercial

General Cleaner – Performs basic cleaning duties such as wiping tables and windows; vacuuming carpets; pantry cleaning; clearing trash bins, cobweb; sweeping apron and surrounding drains, staircases, common corridor, outdoor, carpark/s; mopping lift and lift landing.

Indoor Cleaner – Performs cleaning in a sheltered environment such as wiping tables and windows; vacuuming carpets; pantry cleaning; mopping lift and lift landing. He/she may also perform outdoor cleaning on routine basis.

Restroom Cleaner – Performs cleaning duties in restrooms such as cleaning sanitation fixtures (E.g. cubicles, mirrors, sinks and urinals, refilling tissues, soaps, air fresheners and sanitisers), mopping floor, clearing trash and other general cleaning.

Outdoor Cleaner – An Outdoor Cleaner works in an unsheltered environment and perform duties such as outdoor compound area cleaning jobs, sweeping of car park(s), mopping of lift and lift landing and clearing trash bins.

Cleaning Supervisor – Supervises a team of workers and monitor their performance. Responsible for planning operations, manpower and deployment. They also oversee work execution.

Healthcare Cleaner – Performs housekeeping duties in hospital wards and intensive care units in hospitals and / or perform general cleaning duties in all areas of the hospitals / polyclinics, and at other medical/ healthcare institutions such as private clinics, dental clinics, kidney dialysis centres, etc. His/ her duties may include clearing rubbish, sweeping and mopping the floor.

Multi-skilled Cleaner/ Machine Operator – Uses at least 1 motorized ride-on machinery; or at least 1 lifting equipment; or specialized cleaning agents; or at least 3 handheld machines besides vacuum cleaner, blower and general household cleaning equipment.

Operates motorized equipment to perform duties such as carpet shampooing; marble polishing; leaf blowing; refuse collection; sweeping access road, turf area, open and contained space (E.g. Areas within shopping centres and supermarkets), surrounding road-side and submerge drains, drop-inlet chamber; cleaning high areas of dust and cobwebs, glass panes, or any height cleaning that requires more than 2m access.

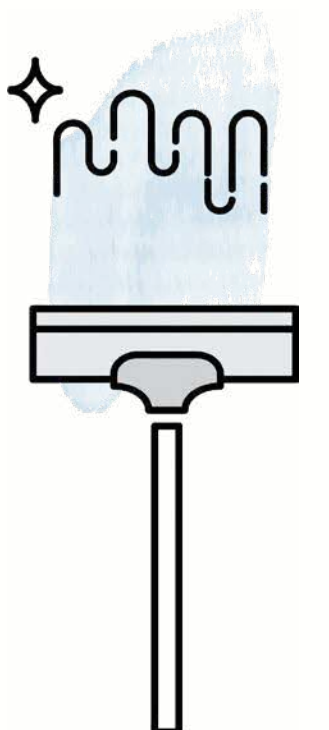

Getting Started

Personal Details

Identification No.

ID Type

Job Details

PWM Minimum Wages

PWM Job Description

Main Job Title

Columns for Financial Institutions

Occupation Group

Type of Employee

Full Time/Part Time

Hours Worked

Contractual Working Hours (Per Week)

Total Paid OT Hours

Total Number of Working Days in the Month

Actual Number of Days/Hours Worked in the Month

Wages & Benefits

Mode of Payment

Basic Wage

Gross Wage Received

Annual Leave Entitlements

Work Location Details

Premise Type

Employee Departure Details

Mode of Leaving

[< Back to PWM Job Description](#)

Landscape

Landscape Worker – Performs 5 general duties: Watering, weeding, pruning, soil aeration and clearing of horticultural waste. He/she is required to observe safety regulations.

Landscape Technician – Performs 5 basic general duties: Watering; weeding; basic pruning; soil aeration and clearing of horticultural waste.

Additional responsibilities also include fertiliser and pesticide treatment, operating motorised equipment and machinery and observing safety regulations.

Assistant Landscape Supervisor – Assists in manpower deployment and supervision. He/she performs maintenance duties and assists to ensure that safety regulations are complied with. He/she is also responsible for reporting and updating of completed work.

Landscape Supervisor – In-charge of manpower deployment and supervision. He/she conducts site inspection and ensures that safety regulations are implemented and complied with. He/she also ensures work schedules are completed on time.

While this is a Sectoral Progressive Wage Model, since 1 September 2022, it has been extended to cover local in-house landscape workers as well.

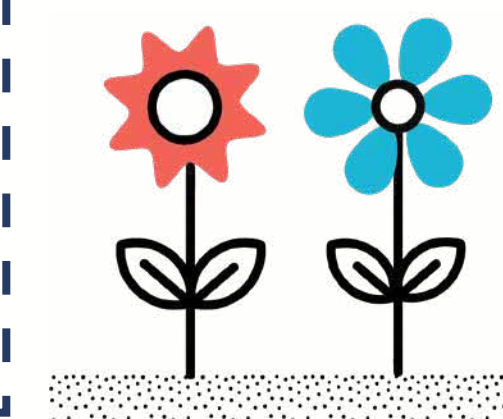

Getting Started

Personal Details

Identification No.

ID Type

Job Details

PWM Minimum Wages

PWM Job Description

Main Job Title

Columns for Financial Institutions

Occupation Group

Type of Employee

Full Time/Part Time

Hours Worked

Contractual Working Hours (Per Week)

Total Paid OT Hours

Total Number of Working Days in the Month

Actual Number of Days/Hours Worked in the Month

Wages & Benefits

Mode of Payment

Basic Wage

Gross Wage Received

Annual Leave Entitlements

Work Location Details

Premise Type

Employee Departure Details

Mode of Leaving

[< Back to PWM Job Description](#)

Food Services

Category A – Quick-Service Food Establishments

Food Drink/Stall Assistant – Prepares and/or serves simple food/drink items from food/drink counters or steam tables in food stalls (generally refers to coffeeshops, food courts, and applies to some fast-food outlets).

Food Service Counter Attendant – Prepares and/or serves simple food/drink items from food/drink counters or steam tables in food shops.

Cook – Supports the preparation of menu dishes.

Senior Cook – Directs and manages the preparation of menu dishes at one or more kitchen stations.

Kitchen Assistant – Handles basic food preparation.

Category B – Full-Service Food Establishments, Food Caterers, and Central Kitchens

Kitchen Assistant – Handles basic food preparation.

Cook – Supports the preparation of menu dishes.

Senior Cook – Directs and manages the preparation of menu dishes at one or more kitchen stations.

Waiter – Attends directly to customers' needs and supports customer-facing operations.

Waiter Supervisor – Supports the Manager by overseeing customer-facing operations.

Manager – Bears overall responsibility for the profitability of the establishment, and oversees all of the establishment's operations, i.e. both customer-facing and back of house activities (E.g. kitchen, inventory management).

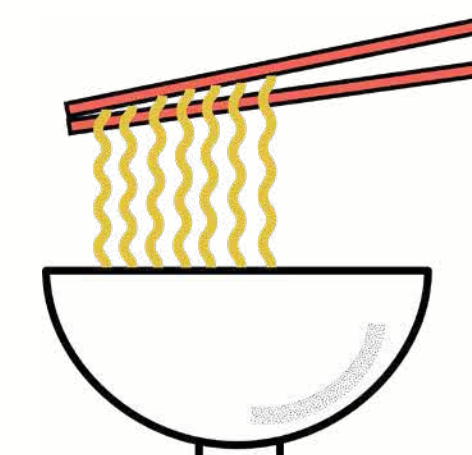

Getting Started

Personal Details

Identification No.

ID Type

Job Details

PWM Minimum Wages

PWM Job Description

Main Job Title

Columns for Financial Institutions

Occupation Group

Type of Employee

Full Time/Part Time

Hours Worked

Contractual Working Hours (Per Week)

Total Paid OT Hours

Total Number of Working Days in the Month

Actual Number of Days/Hours Worked in the Month

Wages & Benefits

Mode of Payment

Basic Wage

Gross Wage Received

Annual Leave Entitlements

Work Location Details

Premise Type

Employee Departure Details

Mode of Leaving

[< Back to PWM Job Description](#)

Lift & Escalator

Specialist – Performs maintenance works independently. He/she attends to breakdowns/callbacks; troubleshoots safety circuits; housekeeps lift motor room, shaft, car top and pit; performs lubrication and cleaning; conducts checks on lift components; replaces minor components; and makes minor adjustment to settings.

Assistant Specialist – Understudies and performs lift maintenance works under supervision. He/she housekeeps the lift motor room, shaft, car top and pit; performs lubrication and cleaning; conducts checks on lift components; replaces minor components; and makes minor adjustment to settings.

Senior Specialist – Performs maintenance works independently. He/she attends to breakdowns/callbacks; troubleshoots safety circuits; housekeeps lift motor room, shaft, car top and pit; performs lubrication and cleaning; conducts checks on lift components; replaces minor and major components; and makes minor and major adjustment to settings.

Principal Specialist – Well-versed in different L&E models and provides technical expertise in troubleshooting and repair. He/she conducts risk and quality assessments; attends to breakdowns/callbacks; troubleshoots safety circuits and complex lift issues; performs root cause analysis (RCA); conducts checks on lift components;

replaces minor and major components; makes minor and major adjustment to settings; and assists supervisor on parts replacement and procurement.

Master Specialist – Forms and leads quality and safety initiatives; conducts risk assessment and quality control; provides mentorship; develops and conducts training (includes safety and technical). He/she also attends to breakdowns/callbacks; troubleshoots safety circuits and complex lift issues; performs root cause analysis (RCA); replaces major components; makes major adjustment to settings; and assists supervisor on parts replacement and procurement.

Supervisor – Is the team lead for maintenance, incident response and recovery, replacement and upgrading. He/she manages the technical team; conducts risk assessment and quality control; writes reports and resolves disputes; and interprets codes, Acts and Regulations.

Senior Supervisor – Supervises the technical team and deploys manpower. He/she conducts risk assessment and quality control; develops and conducts training (includes safety and technical); writes reports and resolves disputes; interprets codes, Acts and Regulations; administers contracts and tendering processes; and prepares contract specifications.

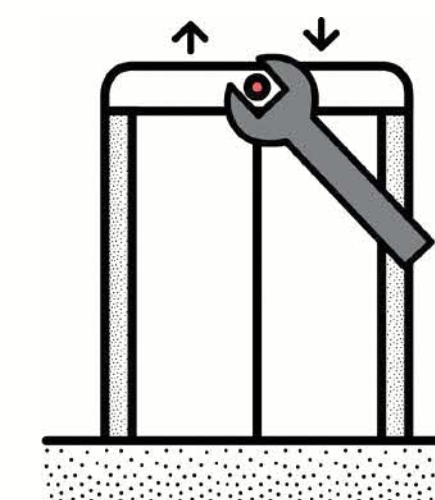

Getting Started

Personal Details

Identification No.

ID Type

Job Details

PWM Minimum Wages

PWM Job Description

Main Job Title

Columns for Financial Institutions

Occupation Group

Type of Employee

Full Time/Part Time

Hours Worked

Contractual Working Hours (Per Week)

Total Paid OT Hours

Total Number of Working Days in the Month

Actual Number of Days/Hours Worked in the Month

Wages & Benefits

Mode of Payment

Basic Wage

Gross Wage Received

Annual Leave Entitlements

Work Location Details

Premise Type

Employee Departure Details

Mode of Leaving

[< Back to PWM Job Description](#)

Security

Security Officer – Secures assigned premises, assets and personnel. He/she patrols and guards premises; detects and deters potential threats; performs access control; conducts security screening; manages incidents and emergencies; attends to enquiries from stakeholders.

Senior Security Officer – Secures assigned premises, assets and personnel. He/she detects and deters potential threats; manages key press; regulates traffic; performs surveillance at the command centre; operates security systems; provides assistance to law enforcement; manages incidents and emergencies; attends to enquiries from stakeholders.

Security Supervisor – Assists to lead a security team to protect assigned premises, assets and personnel. He/she handles medical incidents; compiles incident reports; liaises with other departments and provides relevant information; coaches the team and assesses their performance.

Senior Security Supervisor – Leads a team to protect assigned premises, assets and personnel. He/she plans, deploys and conducts security operation audits; assesses security risks and their mitigation; conducts after action reviews; develops training plans; coaches the team and assesses their performance.

While this is a Sectoral Progressive Wage Model, since 1 September 2022, it has been extended to cover local in-house security officers and supervisors as well.

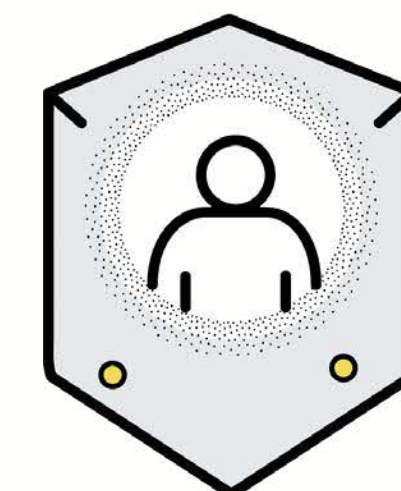

Getting Started

Personal Details

Identification No.

ID Type

Job Details

PWM Minimum Wages

PWM Job Description

Main Job Title

Columns for Financial Institutions

Occupation Group

Type of Employee

Full Time/Part Time

Hours Worked

Contractual Working Hours (Per Week)

Total Paid OT Hours

Total Number of Working Days in the Month

Actual Number of Days/Hours Worked in the Month

Wages & Benefits

Mode of Payment

Basic Wage

Gross Wage Received

Annual Leave Entitlements

Work Location Details

Premise Type

Employee Departure Details

Mode of Leaving

[< Back to PWM Job Description](#)

Waste Collection

Crew – Provides waste and recyclables collection services as directed, handle tools and equipment and incidents.

Senior Crew – Provides waste and recyclables collection services without/with minimal supervision. He/she will also handle tools and equipment and incidents.

Team Lead – Provides waste and recyclables collection services when required, mentor new crews and conduct on-the-job training.

Supervisor – Assists in managing waste and recyclables collection services, inventory, equipment and maintenance schedule, and teams and incidents.

Driver – Carries out waste collection services from site to disposal facilities using a rear end loader, as directed. He/she will handle mechanised tools and equipment, and incidents.

Hooklift Driver – Carries out waste collection services from site to disposal facilities using a hooklift truck, as directed. He/she will handle mechanised tools and equipment, and incidents.

Senior Driver – Carries out waste collection services from site to disposal facilities without/with minimal supervision. He/she will handle mechanised tools and equipment, incidents and lead, supervise and guide/mentor new drivers.

Materials Recovery

Sorter – Performs waste recycling & materials recovery operations as directed. He/she will handle mechanised tools and equipment, and incidents.

Senior Sorter – Performs waste recycling & materials recovery operations without/with minimal supervision and guide new sorters on the job. He/she will handle mechanised tools and equipment and incidents.

Team Lead – Performs waste recycling & materials recovery operations when necessary, mentor new sorters, and conduct on the job training. He/she will handle heavy machineries and equipment when necessary and incidents.

Plant Supervisor – Assists in managing waste recycling materials recovery operations at disposal facility, inventory, equipment and maintenance schedule, teams and incidents.

Machine Operator – Handles heavy machineries and equipment at disposal facility.

Getting Started

Personal Details

Identification No.

ID Type

Job Details

PWM Minimum Wages

PWM Job Description

Main Job Title

Columns for Financial Institutions

Occupation Group

Type of Employee

Full Time/Part Time

Hours Worked

Contractual Working Hours (Per Week)

Total Paid OT Hours

Total Number of Working Days in the Month

Actual Number of Days/Hours Worked in the Month

Wages & Benefits

Mode of Payment

Basic Wage

Gross Wage Received

Annual Leave Entitlements

Work Location Details

Premise Type

Employee Departure Details

Mode of Leaving

[< Back to PWM Job Description](#)

Retail

Cashier – Assists customers in the in-store checkout process as per the company’s Standard Operating Procedures, and may also be required to attend to customers’ queries at the cashier counter where applicable, and to implement all current promotional events during the checkout process.

Senior Cashier – Mentors and guides the work execution of other Cashiers, especially new Cashiers, and also undertakes duties such as planning resources to support the smooth operation in the checkout department and performing the responsibilities of a Cashier.

Retail Assistant – Sells and explains the functions and qualities of goods, assisting customers by pointing out or demonstrating features and merits of an article, managing and maintaining store display standards and arrangement of merchandise as well as stock/shelves replenishment according to the company’s Standard Operating Procedures.

Senior Retail Assistant – Mentors and guides other Retail Assistants, especially new Retail Assistants, and also undertakes duties such as handling customer enquiries on promotions and performing the responsibilities of a Retail Assistant.

Retail Supervisor – Accountable for achieving the assigned team sales targets, and supervises and coordinates the activities of Retail Assistants, Cashiers and third party staff to ensure that operational demands are catered for, and also undertakes duties such as overseeing daily store operations.

Assistant Retail Supervisor – Assists the Retail Supervisor to oversee the daily store operations, and also undertakes duties such as achieving the store’s sales target and maximising profitability.

Retail Manager – Oversees the end-to-end operations of a store or assigned selling departments, ensures store’s Standard Operating Procedures are followed and is empowered to make decisions on customers’ issues/service recovery. The Retail Manager is also responsible for driving, analysing, improving and achieving the store’s sales and service performance.

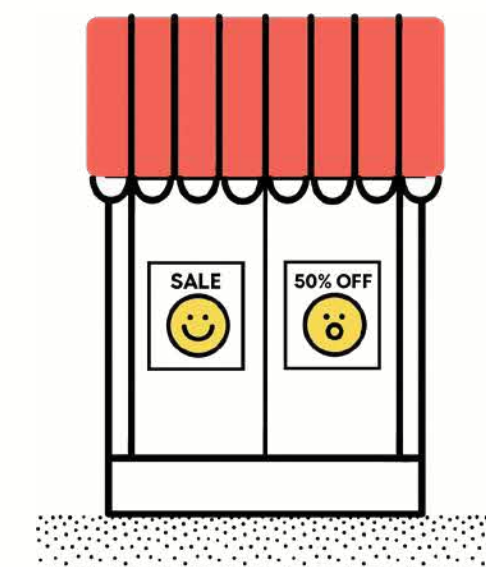

Getting Started

Personal Details

Identification No.

ID Type

Job Details

PWM Minimum Wages

PWM Job Description

Main Job Title

Columns for Financial Institutions

Occupation Group

Type of Employee

Full Time/Part Time

Hours Worked

Contractual Working Hours (Per Week)

Total Paid OT Hours

Total Number of Working Days in the Month

Actual Number of Days/Hours Worked in the Month

Wages & Benefits

Mode of Payment

Basic Wage

Gross Wage Received

Annual Leave Entitlements

Work Location Details

Premise Type

Employee Departure Details

Mode of Leaving

[< Back to PWM Job Description](#)

Administrators

Administrative Assistant – Performs basic administrative tasks, such as data entry, receiving and registering documents, sorting and storing of files, and running of errands.

Administrative Executive – Performs administrative tasks such as money handling, customer-facing tasks (E.g. answering and directing phone calls, providing client information and services), accounting and bookkeeping, management of records (E.g. maintaining and updating filing and inventory), preparing production schedules and secretarial tasks (E.g. arranging appointments, organising meetings).

Administrative Supervisor – Supervises personnel undertaking administrative or clerical activities such as general administration, customer service, records management, and data analysis. Supervisory duties could include personnel management, resolving work problems, and coordinating work between units within an organisation.

Drivers

General Driver – Operates vehicles requiring Class 3 driving licence and below, including but not limited to those driving motorcycles, cars, vans and trams.

Specialised Driver – Operates vehicles requiring Class 4 driving licence and above, including but not limited to those driving lorries, trailer trucks, and buses, or undertakes other specialised driver roles like chauffeurs.

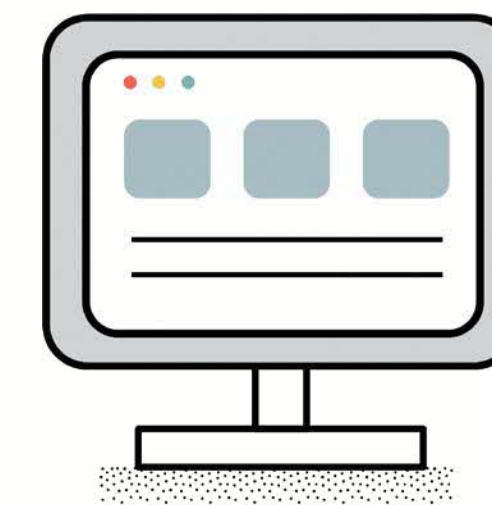

Getting Started

Personal Details

Identification No.

ID Type

Job Details

PWM Minimum Wages

PWM Job Description

Main Job Title

Columns for Financial Institutions

Occupation Group

Type of Employee

Full Time/Part Time

Hours Worked

Contractual Working Hours (Per Week)

Total Paid OT Hours

Total Number of Working Days in the Month

Actual Number of Days/Hours Worked in the Month

Wages & Benefits

Mode of Payment

Basic Wage

Gross Wage Received

Annual Leave Entitlements

Work Location Details

Premise Type

Employee Departure Details

Mode of Leaving

Main Job Title

If an employee holds more than 1 role in their job scope, please indicate their main job title

The main job title can be dependent on the *amount of time spent on that job or the level of priority.*

E.g. Sarah is holding two roles in the Meat Men Butchers company. She is both the *HR Executive and handles deliveries as well.*

*As her HR duties are required for the job most of the time, **HR Executive will be indicated as her Main Job Title.***



Getting Started

Personal Details

Identification No.

ID Type

Job Details

PWM Minimum Wages

PWM Job Description

Main Job Title

Columns for Financial Institutions

Occupation Group

Type of Employee

Full Time/Part Time

Hours Worked

Contractual Working Hours (Per Week)

Total Paid OT Hours

Total Number of Working Days in the Month

Actual Number of Days/Hours Worked in the Month

Wages & Benefits

Mode of Payment

Basic Wage

Gross Wage Received

Annual Leave Entitlements

Work Location Details

Premise Type

Employee Departure Details

Mode of Leaving

For Financial Institutions (Columns K-N)

*These 4 columns (Job Roles, Seniority, Business Area and Geographical Coverage) **need only be completed if the HR representative represents a Financial Institution that has been specifically selected to participate in MAS' Manpower Survey.***

Job Roles

Detailed descriptions of each role can be found in [Annex C](#) of the employee listing.

Seniority

Non-Executive

Refers to employees performing administrative roles; they are typically non-tertiary graduates earning less than \$4k per month.

Analyst / Associate

Refers to employees with less than 3 years of related work experience, including tertiary graduates who are hired directly into specific business areas / job roles.

AVP / VP

Refers to professionals with 3 to less than 8 years of related work experience.

SVP / Director

Refers to professionals with 8 to 15 years of related work experience and with management responsibilities.

*Usually more than 15 years of related work experience

Principles of Classification

Choose the **closest match** to the type and nature of the Job Role / Business Area in the organisation.

For multiple job roles: Reflect employee under the job role that accounts for the most man-hours or best reflects the employee's core responsibility.

MD & Above (Non-Manager)*

Undertakes executive decisions but does not hold a managerial function.

MD & Above (Manager)*

Undertakes executive decisions and who manages teams within the company, whether at the local, regional or global level.

MD & Above (Leader)*

Undertakes executive decisions as part of the management team whether at the local, regional or global level.

MD & Above (Senior Leader)*

Undertakes executive decisions as part of the senior management team and who manages teams within the company whether at local, regional or global level.

Getting Started

Personal Details

Identification No.

ID Type

Job Details

PWM Minimum Wages

PWM Job Description

Main Job Title

Columns for Financial Institutions

Occupation Group

Type of Employee

Full Time/Part Time

Hours Worked

Contractual Working Hours (Per Week)

Total Paid OT Hours

Total Number of Working Days in the Month

Actual Number of Days/Hours Worked in the Month

Wages & Benefits

Mode of Payment

Basic Wage

Gross Wage Received

Annual Leave Entitlements

Work Location Details

Premise Type

Employee Departure Details

Mode of Leaving

For Financial Institutions (Columns K-N)

These 4 columns (Job Roles, Seniority, Business Area and Geographical Coverage) need only be completed if the HR representative represents a Financial Institution that has been specifically selected to participate in MAS' Manpower Survey.

Business Area

- Accountancy
- Asset Management
- Corporate Banking
- Human Resource
- Infocomm Technology
- Insurance
- Investment Banking
- Private Banking and Wealth Management
- Retail Banking
- Sustainability
- Others

Geographical Coverage

Global - Role focuses primarily on supporting activities or clientele in most or all overseas markets in which the group operates.

Regional - Role focuses primarily on supporting activities or clientele in the region (e.g. Southeast Asia, Asia Pacific)

Domestic - Role focuses primarily on supporting activities or clientele originating from Singapore, such as local clients and firms (excludes expatriates and foreign entities based in Singapore)

Global (At least 50%)

E.g. Employee's job scope predominantly covers clients or activities in the Global market.

Regional (At least 50%)

E.g. Employee's job scope predominantly covers clients or activities in the Regional market.

Domestic (100%)

E.g. The role focuses primarily on supporting activities or clientele originating from Singapore, such as local clients and firms (i.e., excluding expatriates, and foreign entities based in Singapore, such as Multi-National Corporations).

Domestic (At least 50%, but less than 100%)

E.g. Employee's work scope relates to the Singapore domestic market AND covers some activities in the Regional or Global market.

Getting Started

Personal Details

Identification No.

ID Type

Job Details

PWM Minimum Wages

PWM Job Description

Main Job Title

Columns for Financial Institutions

Occupation Group

Type of Employee

Full Time/Part Time

Hours Worked

Contractual Working Hours (Per Week)

Total Paid OT Hours

Total Number of Working Days in the Month

Actual Number of Days/Hours Worked in the Month

Wages & Benefits

Mode of Payment

Basic Wage

Gross Wage Received

Annual Leave Entitlements

Work Location Details

Premise Type

Employee Departure Details

Mode of Leaving

Occupation Group

Click the icons to find out more about the group's definition and examples.

You may also search the job role via [SSOC Search](#). The group number reflects the occupation group they are in.

Group 1



Legislators,
Senior Officials
& Managers

Group 2



Professionals

Group 3

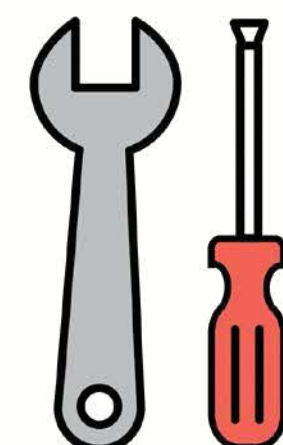

Associate
Professionals
& Technicians

Group 4

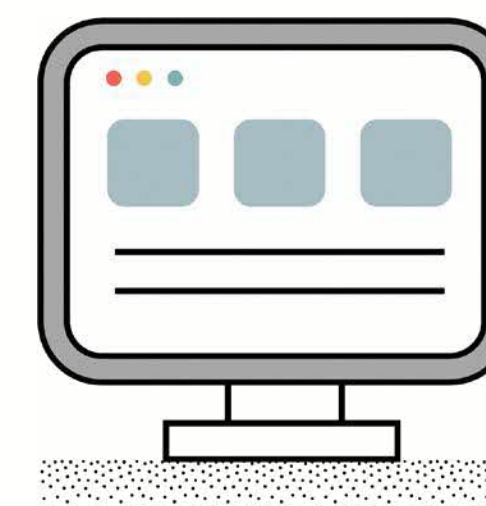

Clerical Support
Workers

Group 5

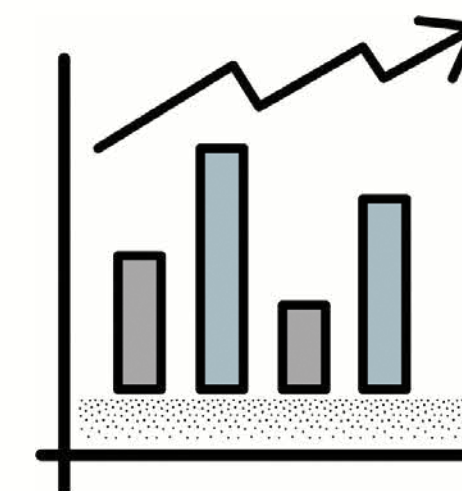

Service & Sales
Workers

Group 6

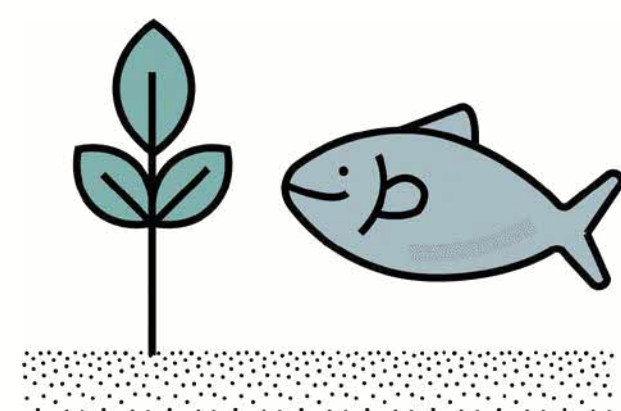

Agricultural &
Fishery Workers

Group 7

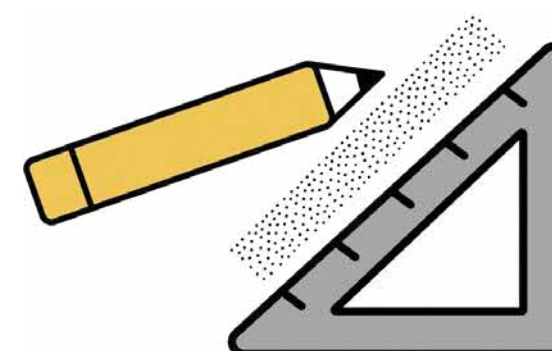

Craftsmen &
Related Trades
Workers

Group 8

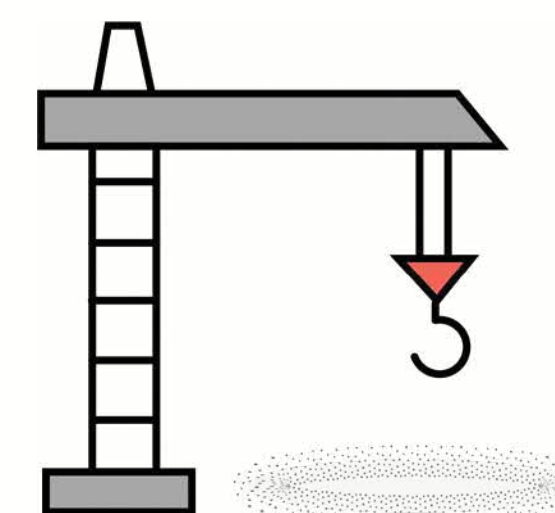

Plant &
Machine
Operators &
Assemblers

Group 9



Cleaners,
Labourers &
Related
Workers

Group 10



Armed Forces &
Foreign
Diplomatic
Personnel

Getting Started

Personal Details

Identification No.

ID Type

Job Details

PWM Minimum Wages

PWM Job Description

Main Job Title

Columns for Financial Institutions

Occupation Group

Type of Employee

Full Time/Part Time

Hours Worked

Contractual Working Hours (Per Week)

Total Paid OT Hours

Total Number of Working Days in the Month

Actual Number of Days/Hours Worked in the Month

Wages & Benefits

Mode of Payment

Basic Wage

Gross Wage Received

Annual Leave Entitlements

Work Location Details

Premise Type

Employee Departure Details

Mode of Leaving

[< Back to Occupation Group](#)

Group 1: Legislators, Senior Officials & Managers

Legislators

These are persons holding senior official positions. They are required to direct or advise on government policies, formulate laws, public rules and regulations, and oversee the interpretation and implementation of government policies and legislation.

Managers

These are persons holding managerial positions. They are required to plan, direct, coordinate and evaluate the overall activities of enterprises or organisational units within them.

Senior managerial appointments (*e.g. Chief Executive Officers, General Managers*) generally require at least a bachelor's degree. There are no standard educational requirements for lower managerial appointments. In some industries, experience and other skill sets such as customer service and industry knowledge may be more important.

The job roles that belong to this occupation group:

- Chief Executive Officers, Chief Operating/ Financial Officers, Managing Directors, General Managers & equivalent
- Finance, Administration, Procurement & Human Resource Managers
- Policy & Planning Managers
- Sales, Marketing, Advertising & Public Relations Managers
- Business Development Managers
- Research & Development Managers
- Premise & Facilities Maintenance Managers
- Landscape Operations Managers
- Customer Service & Call Centre Managers
- Manufacturing & Production Managers
- Construction Managers
- Transport & Warehouse Operations Managers
- Postal Services Managers
- Engineering Services & Quality Assurance Managers
- Travel Agency Managers
- Chief Information Officers, Software, IT services, Network & Communications Managers
- Social Services Managers (*Including childcare, aged care, health, social welfare & education services*)
- Hotel, Food & Beverages Services Managers
- Financial & Insurance Services Managers
- Retail & Wholesale Trade Managers
- Casino, Sports, Recreation & Theme Park Managers
- Karaoke & Nightclub Managers

Getting Started

Personal Details

Identification No.

ID Type

Job Details

PWM Minimum Wages

PWM Job Description

Main Job Title

Columns for Financial Institutions

Occupation Group

Type of Employee

Full Time/Part Time

Hours Worked

Contractual Working Hours (Per Week)

Total Paid OT Hours

Total Number of Working Days in the Month

Actual Number of Days/Hours Worked in the Month

Wages & Benefits

Mode of Payment

Basic Wage

Gross Wage Received

Annual Leave Entitlements

Work Location Details

Premise Type

Employee Departure Details

Mode of Leaving

[< Back to Occupation Group](#)

Group 2: Professionals

These are persons working in professional fields. They are required to apply specialised skills and knowledge in their job duties. Supervision of other workers may be included. Most occupations in this group generally require a bachelor's degree.

The job roles that belong to this occupation group:

- Civil, Environment, Mechanical, Chemical, Electronics, Electrical, Telecommunications, Industrial & Production Engineers
- Financial Compliance Officers
- Trade & Ship Brokers
- Generalist & Specialist Medical Practitioners
- Financial Risk Analysis
- Technical Products Salesmen
- Surgeons
- Fund & Treasury Managers
- IT Project Managers
- Dentists
- Relationship Managers
- IT Security and Quality Assurance Specialists
- Pharmacists
- Securities, Finance, Foreign Exchange, Derivatives & Commodities Dealers/Brokers
- Database & Network Administrators
- Optometrists
- Financial Sales Officers
- System Analysts
- Life Science Professionals
- Lecturers & Teachers
(Ranging from Primary School to Universities)
- Software & Applications, Web & Multimedia Developers
- Radiographers
- Surveyors (Both Land & Water)
- Lawyers & Judges
- Registered Nurses
- Building & Landscape Architects
- Graphic & Multi-media Designers
- Clinical Nurses
- Management, Business, Human Resource & Public Relations Consultants
- Librarians, Archivists & Curators
- Dieticians & Nutritionists
- Creative Directors (Advertising)
- Authors, Journalists & Editors
- Pilots (Aircraft, Commercial Airlines)
- Research Officers & Statisticians
- Social Science Professionals
- Accountants & Auditors
- Market Research Analysts
- Performing Artists (E.g. Actors, Singers, Musicians)
- Financial Analysts
- Ordained Ministers of Religion

Getting Started

Personal Details

Identification No.

ID Type

Job Details

PWM Minimum Wages

PWM Job Description

Main Job Title

Columns for Financial Institutions

Occupation Group

Type of Employee

Full Time/Part Time

Hours Worked

Contractual Working Hours (Per Week)

Total Paid OT Hours

Total Number of Working Days in the Month

Actual Number of Days/Hours Worked in the Month

Wages & Benefits

Mode of Payment

Basic Wage

Gross Wage Received

Annual Leave Entitlements

Work Location Details

Premise Type

Employee Departure Details

Mode of Leaving

[< Back to Occupation Group](#)

Group 3: Associate Professionals & Technicians

Associate Professionals

These are persons holding senior official positions. They are required to direct or advise on government policies, formulate laws, public rules and regulations, and oversee the interpretation and implementation of government policies and legislation.

The job roles that belong to this occupation group:

- Assistant Engineers
- Draughtsmen
- Pre-Primary Education Teachers
- Credit & Loans Executives
- Facilities Maintenance, Landscape & Parks Officers
- Operations Executive
- Shipping, Clearing & Forwarding Agents
- Sports & Landscape Designers
- Chefs
- Enrolled/Assistant Nurses
- Sales & Marketing Executives
- Private Academic Tutors & Extra-curriculum Instructors
- Business Development Executives
- Advertising Salesmen
- Client Account Service Executives
- Paralegals
- Human Resources & Training Executives
- Opticians
- Conference & Event Planners/ Executives
- Fire & Safety Inspectors
- Non-Ordained Religious Associates
- Ship Pilots (*Air & Sea Traffic Controllers & Navigators*)
- Management Executives
- Insurance & Real Estate Agents
- Assistant Accountants
- Environment & Occupational Health Inspectors
- Interior & Landscape Designers
- Food & Beverages Executives
- Sports, Recreation & Education Centre Executives
- Air, Port, Road & MRT Operations
- Administrative Executives
- Valuers (*E.g. Property*)
- Social Work Associates
- Retail & Wholesale Trade Executives

[Group 3: Technicians >](#)

Getting Started

Personal Details

Identification No.

ID Type

Job Details

PWM Minimum Wages

PWM Job Description

Main Job Title

Columns for Financial Institutions

Occupation Group

Type of Employee

Full Time/Part Time

Hours Worked

Contractual Working Hours (Per Week)

Total Paid OT Hours

Total Number of Working Days in the Month

Actual Number of Days/Hours Worked in the

Month

Wages & Benefits

Mode of Payment

Basic Wage

Gross Wage Received

Annual Leave Entitlements

Work Location Details

Premise Type

Employee Departure Details

Mode of Leaving

[< Back to Occupation Group](#)

Group 3: Associate Professionals & Technicians

Technicians

These are persons performing technical tasks. Most occupations in this group generally require a diploma or professional qualification not equivalent to a degree. Persons who perform technical work at a lower level, generally not requiring diploma qualifications should be classified as a tradesman (e.g. electrician), and not as a technician.

The job roles that belong to this occupation group:

- Medical Laboratory Technicians
- Life Science Technicians
- Computer Technicians *(E.g.Helpdesk)*
- Manufacturing & Production Engineering Technicians
- Pharmaceutical Technicians
- Broadcasting Operations & Telecommunications Technicians
- Civil, Mechanical, Chemical, Electronics & Electrical Technicians
- Audio-Visual Operators
- Medical Imaging & Therapeutic Equipment Technicians
- Veterinary Technicians
- Petroleum & Natural Gas Technicians

Getting Started

Personal Details

Identification No.

ID Type

Job Details

PWM Minimum Wages

PWM Job Description

Main Job Title

Columns for Financial Institutions

Occupation Group

Type of Employee

Full Time/Part Time

Hours Worked

Contractual Working Hours (Per Week)

Total Paid OT Hours

Total Number of Working Days in the Month

Actual Number of Days/Hours Worked in the Month

Wages & Benefits

Mode of Payment

Basic Wage

Gross Wage Received

Annual Leave Entitlements

Work Location Details

Premise Type

Employee Departure Details

Mode of Leaving

[< Back to Occupation Group](#)

Group 4: Clerical Support Workers

These are persons performing clerical job duties. Most occupations in this group generally require a secondary or post-secondary qualification.

The job roles that belong to this occupation group:

- General Office Clerks
- Accounting & Bookkeeping Clerks
- Finance & Insurance Clerks
- Date Entry / Date Processing Clerks
- Production Clerks
- Transport & Stock Clerks
- Legal Clerks
- Customer Service Officers/ Clerks
- Secretaries
- Telephone Operators
- Receptionists
- Bank Operators Clerks
- Bank Tellers
- Travel Services Clerks
- Survey Interviewers

Getting Started

Personal Details

Identification No.

ID Type

Job Details

PWM Minimum Wages

PWM Job Description

Main Job Title

Columns for Financial Institutions

Occupation Group

Type of Employee

Full Time/Part Time

Hours Worked

Contractual Working Hours (Per Week)

Total Paid OT Hours

Total Number of Working Days in the Month

Actual Number of Days/Hours Worked in the Month

Wages & Benefits

Mode of Payment

Basic Wage

Gross Wage Received

Annual Leave Entitlements

Work Location Details

Premise Type

Employee Departure Details

Mode of Leaving

[< Back to Occupation Group](#)

Group 5: Service & Sales Workers

These are persons performing performing sales, personal or protective services. Most occupations in this group generally require a secondary or post-secondary qualification.

The job roles that belong to this occupation group:

- Cooks
- Waiters & Bartenders
- Cashiers
- Sales Supervisors/ Demonstrators
- Shop Sales Assistants
- Stall Holders
- Child Care Workers
- Hairdressers
- Beauticians
- Mail Carriers (*E.g. Postmen*)
- Telemarketers
- Tour Guides
- Cabin Stewards
- Casino Bookmarkers & Croupiers
- Healthcare Assistants
- Hotel Housekeeping, Supervisors/ Stewards
- Petrol Station Attendants
- Private Security Guards
- Auxiliary Police/ Investigators
- Lifeguards

Getting Started

Personal Details

Identification No.

ID Type

Job Details

PWM Minimum Wages

PWM Job Description

Main Job Title

Columns for Financial Institutions

Occupation Group

Type of Employee

Full Time/Part Time

Hours Worked

Contractual Working Hours (Per Week)

Total Paid OT Hours

Total Number of Working Days in the Month

Actual Number of Days/Hours Worked in the Month

Wages & Benefits

Mode of Payment

Basic Wage

Gross Wage Received

Annual Leave Entitlements

Work Location Details

Premise Type

Employee Departure Details

Mode of Leaving

[< Back to Occupation Group](#)

Group 6: Agricultural & Fishery Workers

These are persons who manage and harvest crops, rear livestock and gather fish.

The job roles that belong to this occupation group:

- Vegetable Farm Workers
- Animal Producers
- Aquaculture Workers

Getting Started

Personal Details

Identification No.

ID Type

Job Details

PWM Minimum Wages

PWM Job Description

Main Job Title

Columns for Financial Institutions

Occupation Group

Type of Employee

Full Time/Part Time

Hours Worked

Contractual Working Hours (Per Week)

Total Paid OT Hours

Total Number of Working Days in the Month

Actual Number of Days/Hours Worked in the Month

Wages & Benefits

Mode of Payment

Basic Wage

Gross Wage Received

Annual Leave Entitlements

Work Location Details

Premise Type

Employee Departure Details

Mode of Leaving

[< Back to Occupation Group](#)

Group 7: Craftsmen & Related Trades Workers

These are persons involved in skilled trades. Most occupations in this group generally require a secondary or post-secondary qualification.

The job roles that belong to this occupation group:

- Supervisors & General Foremen
- Metal Trade Workers (*E.g. Welders, Boilermakers, Structural steel workers, Blacksmiths, Toolmakers*)
- Telecommunications Installers & Linemen
- Landscape Technicians
- Electricians
- Electrical & Electronics Fitters
- Precision Tradesmen (*E.g. Jewellery workers, Goldsmiths*)
- Skilled Construction Workers (*E.g. Bricklayers, Floor/Wall tilers, Cement finishers, Concreters, Carpenters, Building painters*)
- Bakers, Pastry & Confectionery Makers
- Meat & Fish Preparers
- Tea & Coffee Tasters
- Cabinet Makers

Getting Started

Personal Details

Identification No.

ID Type

Job Details

PWM Minimum Wages

PWM Job Description

Main Job Title

Columns for Financial Institutions

Occupation Group

Type of Employee

Full Time/Part Time

Hours Worked

Contractual Working Hours (Per Week)

Total Paid OT Hours

Total Number of Working Days in the Month

Actual Number of Days/Hours Worked in the Month

Wages & Benefits

Mode of Payment

Basic Wage

Gross Wage Received

Annual Leave Entitlements

Work Location Details

Premise Type

Employee Departure Details

Mode of Leaving

[< Back to Occupation Group](#)

Group 8: Plant & Machine Operators & Assemblers

These are persons involved in manufacturing processes, maintenance and repair of machines and operating transport equipment. Most occupations in this group generally require a secondary or post-secondary qualification.

The job roles that belong to this occupation group:

- Stationary Plant & Machine Supervisors
- Plant Operators (*E.g. Petroleum, Natural gas, Power generating*)
- Assemblers
- Electrical & Electronic Fitters
- Quality Checkers & Testers
- Light Vehicle Drivers
- MRT Train Operators
- Motorcycle Delivery Men
- Mobile Machinery Operators (*E.g. Bulldozer, Drilling machine, Crane & Fork lift truck*)
- Machine Operators (*E.g. metal processing, rubber & plastics, food products, pharmaceutical*)
- Heavy Vehicle Drivers (*E.g. Lorry, Trailer truck, Air/sea port mobile, Concrete mixer*)
- Retail & Wholesale Trade Executives
- Interior & Landscape Designers

Getting Started

Personal Details

Identification No.

ID Type

Job Details

PWM Minimum Wages

PWM Job Description

Main Job Title

Columns for Financial Institutions

Occupation Group

Type of Employee

Full Time/Part Time

Hours Worked

Contractual Working Hours (Per Week)

Total Paid OT Hours

Total Number of Working Days in the Month

Actual Number of Days/Hours Worked in the

Month

Wages & Benefits

Mode of Payment

Basic Wage

Gross Wage Received

Annual Leave Entitlements

Work Location Details

Premise Type

Employee Departure Details

Mode of Leaving

[< Back to Occupation Group](#)

Group 9: Cleaners, Labourers and Related Workers

These are persons involved in simple and routine tasks, which may require the use of hand-held tools and considerable physical effort. Most occupations in this group generally require primary or no formal education.

The job roles that belong to this occupation group:

- Cleaners (E.g. Hotels, Offices, Restaurants, Food courts, Hawkers centres, Residential, Industrial, Open areas)
- Chambermaid
- Building Watchmen
- Other cleaners (E.g. Window, Vehicle, Ship, Aircraft, Rail carriage)
- Attendants (E.g. Lorry, Restroom, Hospital, Car park, Recreation & Sports facilities)
- Park & Garden Maintenance Workers (E.g. Grass, Tree cutter)
- Construction Labourers
- Material & Freight Handlers
- Hand Packers
- Kitchen Assistants/ Dish Washers
- Fast Food Preparers
- Waste & Recyclables Collection Workers
- Agriculture & Fishery Labourers
- Coffee/Tea Servers

Getting Started

Personal Details

Identification No.

ID Type

Job Details

PWM Minimum Wages

PWM Job Description

Main Job Title

Columns for Financial Institutions

Occupation Group

Type of Employee

Full Time/Part Time

Hours Worked

Contractual Working Hours (Per Week)

Total Paid OT Hours

Total Number of Working Days in the Month

Actual Number of Days/Hours Worked in the Month

Wages & Benefits

Mode of Payment

Basic Wage

Gross Wage Received

Annual Leave Entitlements

Work Location Details

Premise Type

Employee Departure Details

Mode of Leaving

[< Back to Occupation Group](#)

Group 10: Armed Forces and Foreign Diplomatic Personnel

This group includes personnel who are serving in the armed forces (including auxiliary services), foreign diplomats, and consular representatives.

The job roles that belong to this occupation group:

- Foreign Diplomats
- Military Experts
- Military Officers
- Army Engineers
- Foreign Service Officer stationed in Singapore

Getting Started

Personal Details

Identification No.

ID Type

Job Details

PWM Minimum Wages

PWM Job Description

Main Job Title

Columns for Financial Institutions

Occupation Group

Type of Employee

Full Time/Part Time

Hours Worked

Contractual Working Hours (Per Week)

Total Paid OT Hours

Total Number of Working Days in the Month

Actual Number of Days/Hours Worked in the Month

Wages & Benefits

Mode of Payment

Basic Wage

Gross Wage Received

Annual Leave Entitlements

Work Location Details

Premise Type

Employee Departure Details

Mode of Leaving

Type of Employee

1. **Trainee** – Refers to trainees or interns in the organisation.
2. **Temporary/Contract (<1 year)** – Refers to employees on a contract duration of less than 1 year, including casual/on-call workers, and **excluding** trainees or interns.
3. **Worked Partly or not at all in the month** – E.g. Worked partly or not at all in June 2021. *This refers to employees who worked partly or did not work in June 2021 (E.g. Joined or left during the month of June 2021, on leave of absence or no-pay leave).*
4. **NIL** – Please select the option “NIL” when other options are not applicable.

Getting Started

Personal Details

Identification No.

ID Type

Job Details

PWM Minimum Wages

PWM Job Description

Main Job Title

Columns for Financial Institutions

Occupation Group

Type of Employee

Full Time/Part Time

Hours Worked

Contractual Working Hours (Per Week)

Total Paid OT Hours

Total Number of Working Days in the Month

Actual Number of Days/Hours Worked in the Month

Wages & Benefits

Mode of Payment

Basic Wage

Gross Wage Received

Annual Leave Entitlements

Work Location Details

Premise Type

Employee Departure Details

Mode of Leaving

Full-Time / Part-Time

To determine if an employee is a full-timer or part-timer, refer to details in the employment contract.

Employment Details	
Job Designation	Part-Time Barista

Employment contract excerpt 1

First, check if the job title states whether the employee is a full-timer or part-timer.

This employee is a part-timer.

Remuneration Details	
Basic Salary	\$4,500/month

Employment contract excerpt 2

If the job title does not state, check the mode of payment.

This employee is paid monthly, indicating that they are a full-timer. Conversely, an employee will be considered a part-timer if they are paid an hourly rate e.g. \$10/hour.

Getting Started

Personal Details

Identification No.

ID Type

Job Details

PWM Minimum Wages

PWM Job Description

Main Job Title

Columns for Financial Institutions

Occupation Group

Type of Employee

Full Time/Part Time

Hours Worked

Contractual Working Hours (Per Week)

Total Paid OT Hours

Total Number of Working Days in the Month

Actual Number of Days/Hours Worked in the Month

Wages & Benefits

Mode of Payment

Basic Wage

Gross Wage Received

Annual Leave Entitlements

Work Location Details

Premise Type

Employee Departure Details

Mode of Leaving

Contractual Working Hours (Per Week)

This refers to the number of contractual working hours in a normal working week that the employee and employer have agreed to, either in written form (E.g. Contract of service) or through verbal communication.

If part-time workers do not have fixed regular contractual working hours, please indicate the average working hours per week this can be calculated using:

[Actual working hours of the month x 12 (months)] / 52 (weeks)]*

**Round up to 1 decimal place if it is not a whole number*

[See example on the next page >>](#)

Getting Started**Personal Details**

Identification No.

ID Type

Job Details

PWM Minimum Wages

PWM Job Description

Main Job Title

Columns for Financial Institutions

Occupation Group

Type of Employee

Full Time/Part Time

Hours Worked

Contractual Working Hours (Per Week)

Total Paid OT Hours

Total Number of Working Days in the Month

Actual Number of Days/Hours Worked in the Month

Wages & Benefits

Mode of Payment

Basic Wage

Gross Wage Received

Annual Leave Entitlements

Work Location Details

Premise Type

Employee Departure Details

Mode of Leaving

Contractual Working Hours (Per Week)

Example #1:

Ben is a full-time art teacher. His contract states that he is required to work **Mondays to Fridays, from 10 – 7pm, with a 1 hour break for lunch.**

Ben's Contractual Working Hours* Per Day: 8 hours

In this column, his OED employee listing should reflect as 40 Contractual Working Hours (Per Week).

** Contractual Working Hours excludes hours allocated for meal breaks*

Example #2:

Sarah is a **part-time** events promoter with an **irregular work schedule.**

This was her work schedule in May:

3rd, 5th, 8th May (3 days) : 5 hours /day

10th, 11th, 12th, 13th May (4 days) : 2 hours /day

15th, 18th, 23th, 24th, 25th May (5 days) : 7 hours /day

Actual Number of Hours Worked in May: 58 Hours

Formula: $58 \times 12 / 52 = 13.4$ hours (round up to 1 decimal point)

In this column, her OED employee listing should reflect as 13.4 Contractual Working Hours (Per Week).

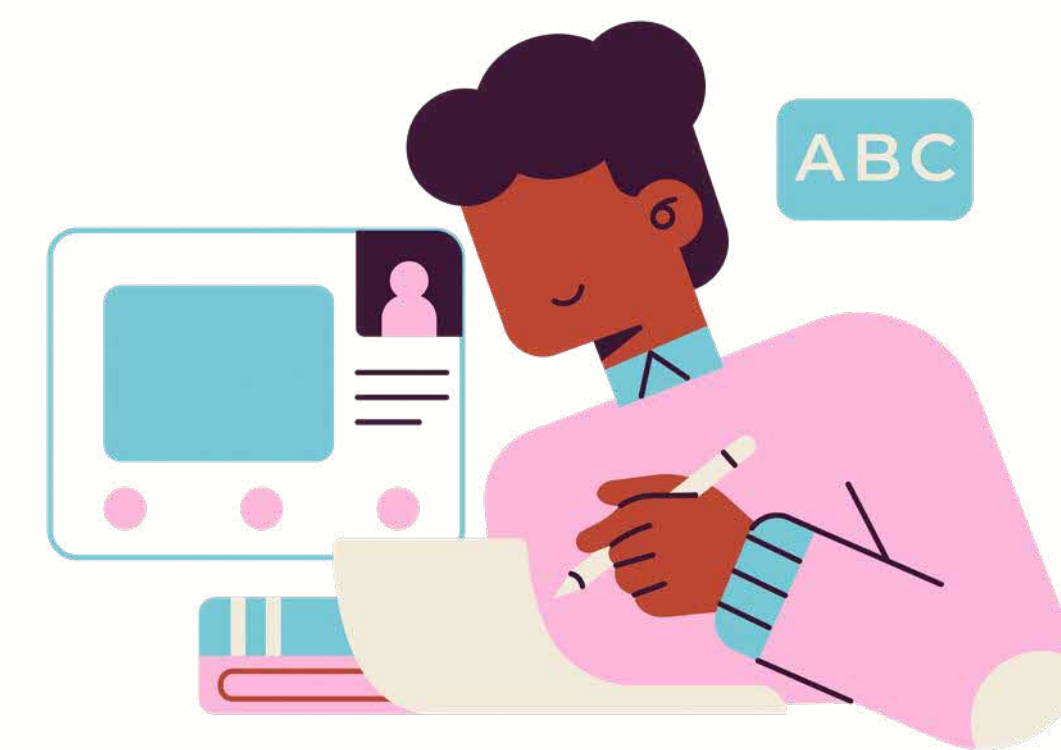

Getting Started**Personal Details**

Identification No.

ID Type

Job Details

PWM Minimum Wages

PWM Job Description

Main Job Title

Columns for Financial Institutions

Occupation Group

Type of Employee

Full Time/Part Time

Hours Worked

Contractual Working Hours (Per Week)

Total Paid OT Hours

Total Number of Working Days in the Month

Actual Number of Days/Hours Worked in the Month

Wages & Benefits

Mode of Payment

Basic Wage

Gross Wage Received

Annual Leave Entitlements

Work Location Details

Premise Type

Employee Departure Details

Mode of Leaving

Total Paid OT Hours

This refers to the number of paid hours spent working overtime in the given month, with these hours used for the official computation of an employee's overtime pay.

INCLUDE:

All forms of paid overtime hours of work

(Note: If an employee's total paid OT hours is more than 72 hours, it has to be indicated as 72.0 in the Employee Listing. This is because an employee can only work a maximum of 72 overtime hours per month.)

EXCLUDE:

Unpaid overtime hours

(E.g. Overtime hours that do not contribute to overtime pay; if an employee does not receive overtime pay, regardless of the amount of overtime hours put in, their paid overtime hours should be zero)

Example:

Ian is a Retail Assistant Manager earning \$5500 a month. Because of operational needs, he had to work 34 extra hours compared to his usual schedule last month.

However, he is not eligible for paid overtime hours.

In this column, his OED employee listing should reflect as 0.0 Total Paid OT Hours.



Getting Started

Personal Details

Identification No.

ID Type

Job Details

PWM Minimum Wages

PWM Job Description

Main Job Title

Columns for Financial Institutions

Occupation Group

Type of Employee

Full Time/Part Time

Hours Worked

Contractual Working Hours (Per Week)

Total Paid OT Hours

Total Number of Working Days in the Month

Actual Number of Days/Hours Worked in the Month

Wages & Benefits

Mode of Payment

Basic Wage

Gross Wage Received

Annual Leave Entitlements

Work Location Details

Premise Type

Employee Departure Details

Mode of Leaving

Total Number of Working Days in the Month

For Part-Time Employees: To follow Total Amount of Hours clocked in the month (same as Actual Number of Hours worked)

Refers to the total number of working days* that the employee is supposed to work in the month of assessment, assuming that they worked a complete month.

**Public Holiday counts towards a working day*

This applies to employees who have taken paid or unpaid leave in the month, or new joiners and leavers who have not worked the full month.

With this data, employees will be assessed based on pro-rated PWM/LQS wage threshold for the monthly PWM/LQS assessment.

In short, Total Number of Working Days in the Month = total number of days an employee will work over an entire month, based on their contract terms.

[See example on the next page >>](#)

Getting Started

Personal Details

Identification No.

ID Type

Job Details

PWM Minimum Wages

PWM Job Description

Main Job Title

Columns for Financial Institutions

Occupation Group

Type of Employee

Full Time/Part Time

Hours Worked

Contractual Working Hours (Per Week)

Total Paid OT Hours

Total Number of Working Days in the Month

Actual Number of Days/Hours Worked in the Month

Wages & Benefits

Mode of Payment

Basic Wage

Gross Wage Received

Annual Leave Entitlements

Work Location Details

Premise Type

Employee Departure Details

Mode of Leaving

Total Number of Working Days in the Month

The month of December 2023 is included as a reference for companies completing surveys in January 2024

Example:

John is a full-time accountant. His contract states that he is required to work Mondays to Fridays.

For the month of May 2024:

31 (Total days in May) - 8 (Weekends) = 23 (Total Number of Working Days)

Note: Although Labour Day was celebrated on Wednesday as a Public Holiday in May, it will still be counted towards the Total Number of Working Days.

In this column, his OED Employee Listing should reflect as 23 days.

No. of working days per month Reference table for year <u>2023</u>						
				If respondent works:		
Month of 2023	Calendar Days	No. of Sundays	No. of Saturdays	5 day work week	5.5 day work week	6 day work week
December	31	5	5	21	23.5	26

No. of working days per month Reference table for year <u>2024</u>						
				If respondent works:		
Month of 2024	Calendar Days	No. of Sundays	No. of Saturdays	5 day work week	5.5 day work week	6 day work week
Jan	31	4	4	23	25	27
Feb	29	4	4	21	23	25
Mar	31	5	5	21	23.5	26
April	30	4	4	22	24	26
May	31	4	4	23	25	27
June	30	5	5	20	22.5	25
July	31	4	4	23	25	27
August	31	4	5	22	24.5	27
September	30	5	4	21	23	25
October	31	4	4	23	25	27
November	30	4	5	21	23.5	26
December	31	5	4	22	24	26

Getting Started

Personal Details

Identification No.

ID Type

Job Details

PWM Minimum Wages

PWM Job Description

Main Job Title

Columns for Financial Institutions

Occupation Group

Type of Employee

Full Time/Part Time

Hours Worked

Contractual Working Hours (Per Week)

Total Paid OT Hours

Total Number of Working Days in the Month

Actual Number of Days/Hours Worked in the Month

Wages & Benefits

Mode of Payment

Basic Wage

Gross Wage Received

Annual Leave Entitlements

Work Location Details

Premise Type

Employee Departure Details

Mode of Leaving

Actual Number of Days/Hours Worked in the Month

To provide the actual number of days worked in the month, including paid public holidays and paid leaves.

For part-time employees, to provide the Actual Number of Hours Worked during the previous month.

[See example on the next page >>](#)

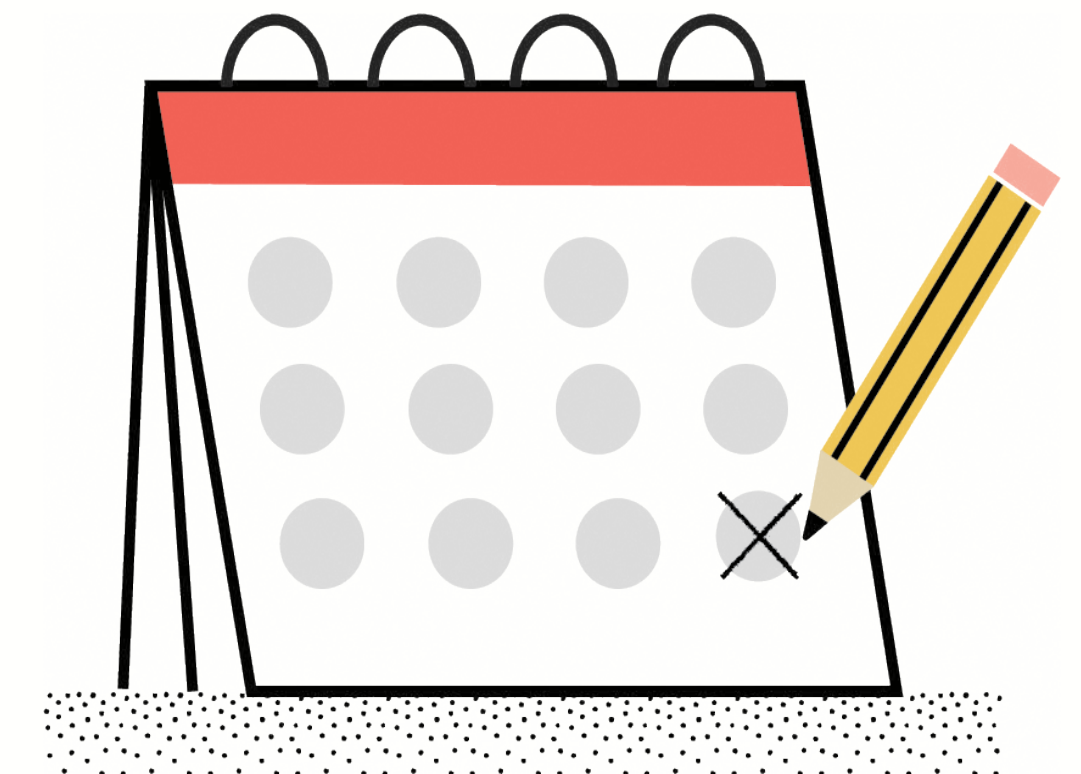

Getting Started**Personal Details**

Identification No.

ID Type

Job Details

PWM Minimum Wages

PWM Job Description

Main Job Title

Columns for Financial Institutions

Occupation Group

Type of Employee

Full Time/Part Time

Hours Worked

Contractual Working Hours (Per Week)

Total Paid OT Hours

Total Number of Working Days in the Month

Actual Number of Days/Hours Worked in the Month

Wages & Benefits

Mode of Payment

Basic Wage

Gross Wage Received

Annual Leave Entitlements

Work Location Details

Premise Type

Employee Departure Details

Mode of Leaving

Actual Number of Working Days in the Month

Example #1:

Stacy is a full-time dressmaker. Her contract states that she is required to work Mondays to Fridays.

For the month of May 2024, there are 23 Total Working days.

Total Number of Leave Days she took in May:

Sick Leave: 2 days

No Pay Leave: 1 day

23 (Total Working Days) - 1 (Total No Pay Leaves Days) = 22 (Actual Number of Days Worked in the Month)

In this column, it should be reflected as 22 Actual Number of Days Worked in the Month for the employee, Stacy.

Example #2:

Adam is a part-time retail assistant. Since Adam is a part-timer, this column should reflect Adam's Actual Number of *Hours Worked* in the Month.

Adam clocked a total of 32 hours for May 2024, hence the column in the OED Listing will show 32.

Getting Started

Personal Details

Identification No.

ID Type

Job Details

PWM Minimum Wages

PWM Job Description

Main Job Title

Columns for Financial Institutions

Occupation Group

Type of Employee

Full Time/Part Time

Hours Worked

Contractual Working Hours (Per Week)

Total Paid OT Hours

Total Number of Working Days in the Month

Actual Number of Days/Hours Worked in the Month

Wages & Benefits

Mode of Payment

Basic Wage

Gross Wage Received

Annual Leave Entitlements

Work Location Details

Premise Type

Employee Departure Details

Mode of Leaving

Mode of Payment

1. **Month** – Employee is paid a fixed monthly basic wage (e.g. \$1,000 per month)
2. **Day** – Employee is paid a fixed daily rate (e.g. \$25 per day)
3. **Hour** – Employee is paid a fixed hourly rate (e.g. \$7 per hour)
4. **Piece-Rated** – Employee is paid solely based on the amount of items produced (E.g. A tailor is paid to sew 3 dresses, a designer is paid to design 1 poster)
5. **Commission** – Employee is paid commission with or without a fixed basic wage (regardless of whether he / she had earned any commission in June 2021)
6. **Others** – Other mode of payment (E.g. Employee is paid solely on a 'per trip', 'per lesson', 'per session' or 'per square meter' basis)

If the employee is receiving a hybrid mode of payment follow the priority below:

Commission > Month / Day / Hour > Piece-Rated > Others

E.g.:

Month / Day / Hour + Piece-Rated: **Select Month / Day / Hour in the OED Employee Listing**

Month / Day / Hour + Commission: **Select Commission in the OED Employee Listing**

Piece-Rated + Commission: **Select Commission in the OED Employee Listing**



Getting Started**Personal Details**

Identification No.

ID Type

Job Details

PWM Minimum Wages

PWM Job Description

Main Job Title

Columns for Financial Institutions

Occupation Group

Type of Employee

Full Time/Part Time

Hours Worked

Contractual Working Hours (Per Week)

Total Paid OT Hours

Total Number of Working Days in the Month

Actual Number of Days/Hours Worked in the Month

Wages & Benefits

Mode of Payment

Basic Wage

Gross Wage Received

Annual Leave Entitlements

Work Location Details

Premise Type

Employee Departure Details

Mode of Leaving

Basic Wage

Refers to a fixed wage for either a full hour, a full day or a full month's work before deductions of employee's share of CPF contribution.

This is to be based on the mode of payment indicated (except for Commission):

(a) INCLUDE:

- The monthly variable component

(b) EXCLUDE:

- (i) Employer's share of contribution to the CPF
- (ii) Overtime, bonus, commissions, service points, productivity incentive payments
- (iii) Regular allowances (E.g. shift, food, housing, transport)
- (iv) Any form of reimbursement (E.g. meal, transport, medical)
- (v) Skill Development Levy (*SDL*)
- (vi) Other lump sum payments (E.g. leave encashment, gratuity)



Getting Started

Personal Details

Identification No.

ID Type

Job Details

PWM Minimum Wages

PWM Job Description

Main Job Title

Columns for Financial Institutions

Occupation Group

Type of Employee

Full Time/Part Time

Hours Worked

Contractual Working Hours (Per Week)

Total Paid OT Hours

Total Number of Working Days in the Month

Actual Number of Days/Hours Worked in the Month

Wages & Benefits

Mode of Payment

Basic Wage

Gross Wage Received

Annual Leave Entitlements

Work Location Details

Premise Type

Employee Departure Details

Mode of Leaving

Gross Wage

Refers to all remuneration received by an employee before deductions of the employee's share of CPF contribution, lateness for work, equipment spoilage, personal income tax and other amounts payable by the employee.

(a) INCLUDE:

- (i) Overtime payments
- (ii) Commissions, service points
- (iii) Regular allowances (E.g. Shift, food, housing, transport)
- (iv) Other regular cash payment
- (v) Remuneration paid by MINDEF to employees who underwent In-Camp Training in the month

(b) EXCLUDE:

- (i) Employer's share of contribution to the CPF
- (ii) Bonus, productivity incentive payments (Variable payment made as an incentive to increase productivity or reward employees, E.g. for good attendance and punctuality)
- (iii) Skill Development Levy (*SDL*)
- (iv) Other lump sum payments (E.g. Leave encashment, gratuity)

Getting Started

Personal Details

Identification No.
ID Type

Job Details

PWM Minimum Wages
PWM Job Description
Main Job Title
Columns for Financial Institutions
Occupation Group
Type of Employee
Full Time/Part Time

Hours Worked

Contractual Working Hours (Per Week)
Total Paid OT Hours
Total Number of Working Days in the Month
Actual Number of Days/Hours Worked in the Month

Wages & Benefits

Mode of Payment
Basic Wage
Gross Wage Received
Annual Leave Entitlements

Work Location Details

Premise Type

Employee Departure Details

Mode of Leaving

Annual Leave Entitlements

Refers to the leave entitlement of full-time employees for a year of service.
For employees on probation, please state their annual leave entitlement after the probation period; do not pro-rate their annual leave.



Getting Started**Personal Details**

Identification No.

ID Type

Job Details

PWM Minimum Wages

PWM Job Description

Main Job Title

Columns for Financial Institutions

Occupation Group

Type of Employee

Full Time/Part Time

Hours Worked

Contractual Working Hours (Per Week)

Total Paid OT Hours

Total Number of Working Days in the Month

Actual Number of Days/Hours Worked in the Month

Wages & Benefits

Mode of Payment

Basic Wage

Gross Wage Received

Annual Leave Entitlements

Work Location Details

Premise Type

Employee Departure Details

Mode of Leaving

Premise Type

If employee has multiple locations, select the premise based on most time spent.

If employee spends an equal amount of time at 2 locations, follow the Hierarchy shown here.

1. Headquarters (HQ)

– The corporate main office where an establishment's executive management or key managerial and support staff are usually located.

2. Branch

– A location where business is conducted other than the main office. Examples include retail outlets, satellite offices and community centres.

3. Client's Premise

– A location where an employee is deployed to perform their job duties. Examples include IT consultants, security guards and cleaners who are outsourced by the clients.

4. Mobile

– Applicable for employees with mobile working arrangements or no fixed working location.

5. Working From Home (WFH)

– Applicable for employees who undertake work in their homes more than half the time.

6. Stationed Overseas

– Applicable for employees whose work location is not in Singapore.

Getting Started

Personal Details

Identification No.

ID Type

Job Details

PWM Minimum Wages

PWM Job Description

Main Job Title

Columns for Financial Institutions

Occupation Group

Type of Employee

Full Time/Part Time

Hours Worked

Contractual Working Hours (Per Week)

Total Paid OT Hours

Total Number of Working Days in the Month

Actual Number of Days/Hours Worked in the Month

Wages & Benefits

Mode of Payment

Basic Wage

Gross Wage Received

Annual Leave Entitlements

Work Location Details

Premise Type

Employee Departure Details

Mode of Leaving

Mode of Leaving

1. Resignation

2. Expiry of Term Contract (Written/Verbal)

3. Retirement

4. Retrenchment

- For permanent employees, this refers to the laying off of employees due to redundancy
- For term-contract employees, this refers to employees whose term contracts were terminated prematurely due to redundancy

5. Dismissal (including termination due to poor performance)

6. Transfer to Subsidiaries/Associate Organisations

7. Others (E.g. Employees who left because of medical reasons, death)

Getting Started

Personal Details

Identification No.

ID Type

Job Details

PWM Minimum Wages

PWM Job Description

Main Job Title

Columns for Financial Institutions

Occupation Group

Type of Employee

Full Time/Part Time

Hours Worked

Contractual Working Hours (Per Week)

Total Paid OT Hours

Total Number of Working Days in the Month

Actual Number of Days/Hours Worked in the

Month

Wages & Benefits

Mode of Payment

Basic Wage

Gross Wage Received

Annual Leave Entitlements

Work Location Details

Premise Type

Employee Departure Details

Mode of Leaving

If you need any help updating your OED

Contact us at:

Hotline: **63207722** (Monday to Friday, 8:30am to 5:30pm)

Email: **MOM_OED@mom.gov.sg**

(Include your organisation's UEN in the subject line of the email)

To find out more about OED, you can read our FAQ [here!](#)

